

OTHER SIZE SOLENOID COIL DATA

Coil Must Be Installed With Letter Up

Unit=Millimeters

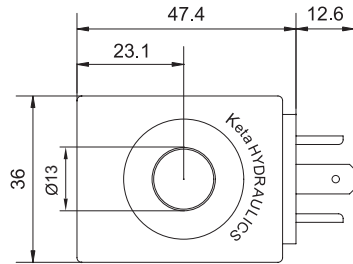

HIRSCHMAN

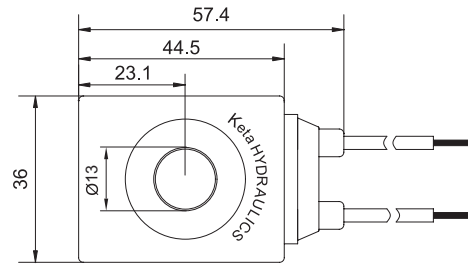

DOUBLE LEADS

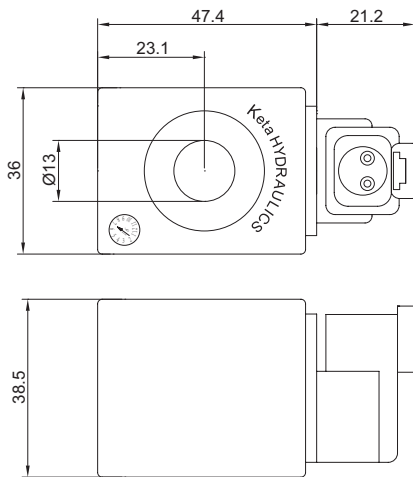

DEUTSCH CONNECTOR

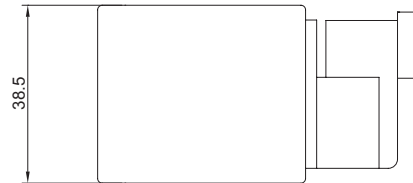
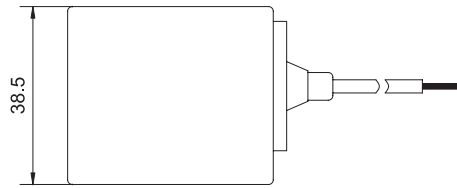
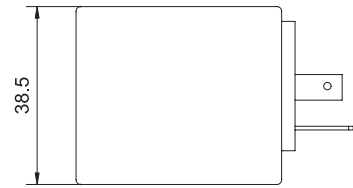

TO ORDER

LC6 - 08 - S - * *

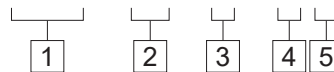

1	Function	4	Coil Voltage	5	Coil Connector Type
	LC6=Solenoid Coil		1=12 VDC RED LEAD		D= Double Lead
			2=24 VDC BLUE LEAD		H= Hirschmann
			3=110VAC BLACK LEAD		ER= Deutsch Connector(Water-proof Coil)
			4=220VAC YELLOW LEAD		IP69K
2	Size				
	08=08 Size				
3	Shape				
	S=Square				